

**NIMEC LIMITED**

**Fast-Easy-Amazing**

# Magnet Energy in Truck Motion

Electricity supply as an option



Economically beneficial



Fossil Fuel Free



Small size

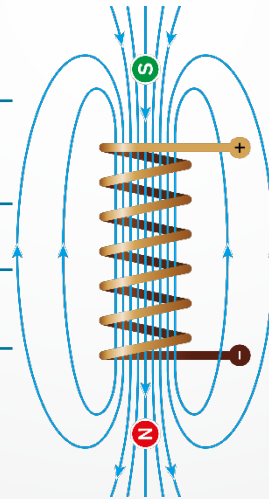

CO<sub>2</sub>

Zero carbon emissions



Quick commissioning time



Multipurpose application



Modular structure

**2025**

Power Generator is coming with ship classification societies certifications, protection for harsh environments, relative humidity >95% option, patented AERP excitation system, PT100 sensors for extra security option, compact design, Leroy-Somer legendary reliability.



**Zero carbon emissions**

High quality hydraulic Rexroth motor hermetically connected to the gearbox. Time-tested and certified Quality. Easy Control System allow to You keep full control and with online option as well.

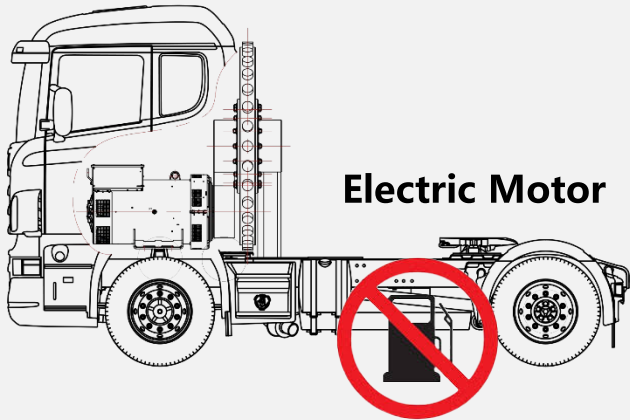
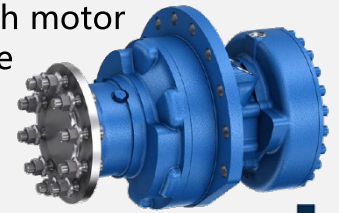

**Electric Motor**

**NO Fossil Fuel is required**

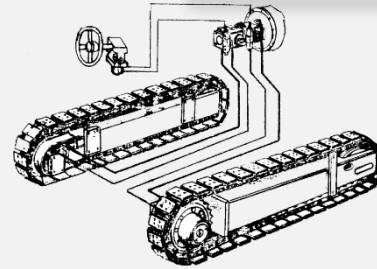
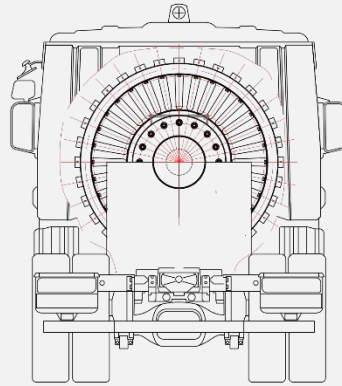

**Hydraulic Motor**

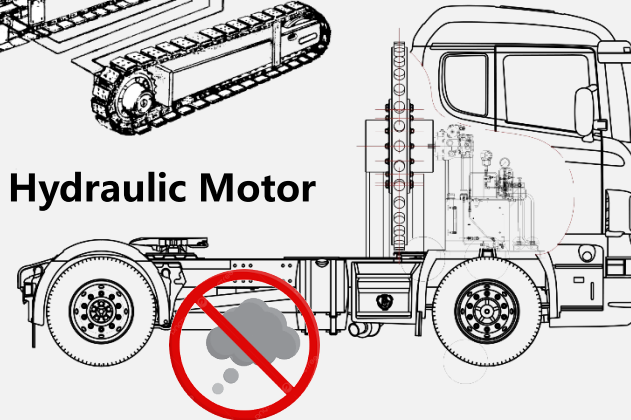

**Absolutely environmentally friendly**

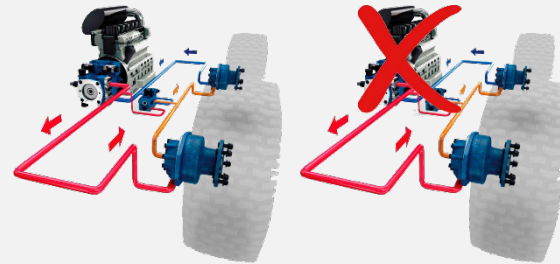

[info@nimecgroup.com](mailto:info@nimecgroup.com)  
[www.nimecgroup.com](http://www.nimecgroup.com)